		EXPTE: 19-PC-17 Nombre Fichero: Planos 19-PC-17-I.dwg (Carpeta ESS) Dibujado por: ATG Revisado por: JVH
E.S.S. (PROYECTO EJECUCIÓN DE DEPÓSITO CON CAPACIDAD DE 600 M3, PARA LA EBAP DE LA ARTERIA DE AGUA DESALADA A SAN CARLOS, ES CANAR Y LA JOYA, SITO JUNTO A IDAM SANTA EULALIA)		
RUTA A CENTRO ASISTENCIAL(ESPECIALIZADO)		Nº PLANO: <h1>05</h1>
PROMOTOR: AYUNTAMIENTO DE SANTA EULALIA DEL RÍO		ESCALA: <h2>S/E</h2>
EMPLAZAMIENTO: POLÍGONO 10 PARCELA 219, SUBPARCELA B, C/NÁPOLES. 07849 SANTA EULARIA DES RIU (ILLES BALEARS)		FIRMA Y SELLO:
JOSE VICENTE HERNANDEZ INGENIERO TECNICO INDUSTRIAL COLEGIADO Nº 918 <small>PASAJE DEL VAPOR MALLORCA, nº 5, BAJO IZQUIERDA. 07840 SANTA EULALIA DEL RIO. Tlf+Fax: 971.33.62.97</small>		
		SEPTIEMBRE 2017

BARANDILLA DE PROTECCIÓN

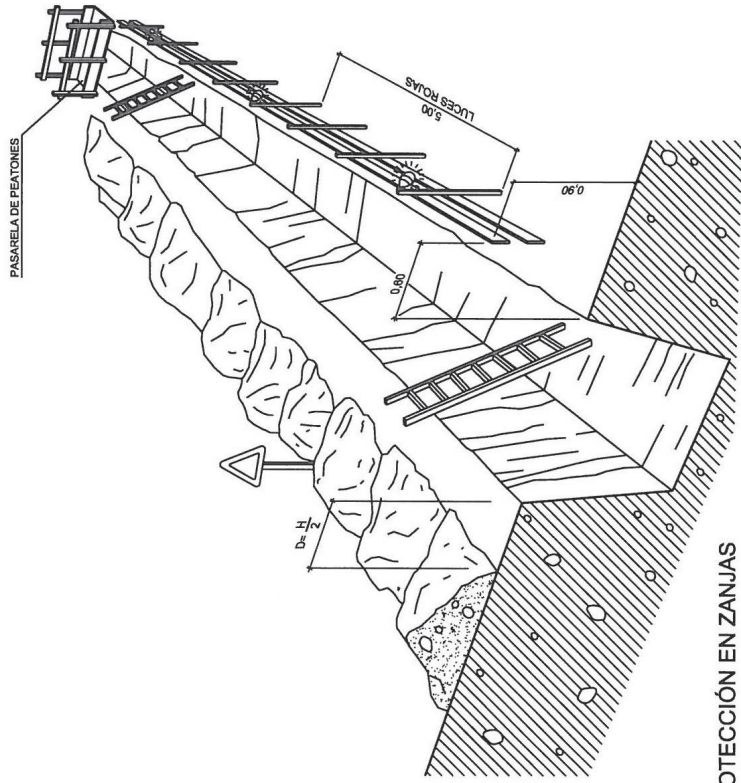

PROTECCIÓN EN ZANJAS

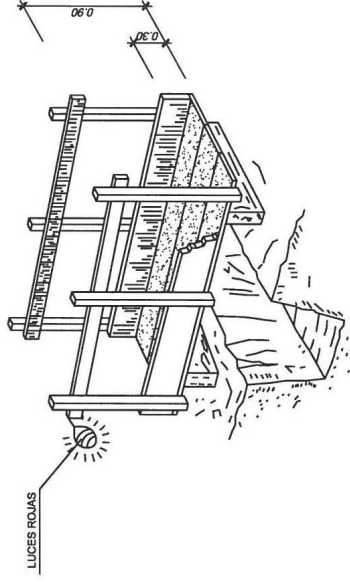

DETALLE DE PASARELA DE PEATONES

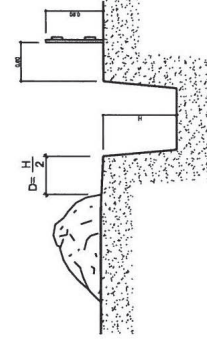

EN TERRENO ARENOSO

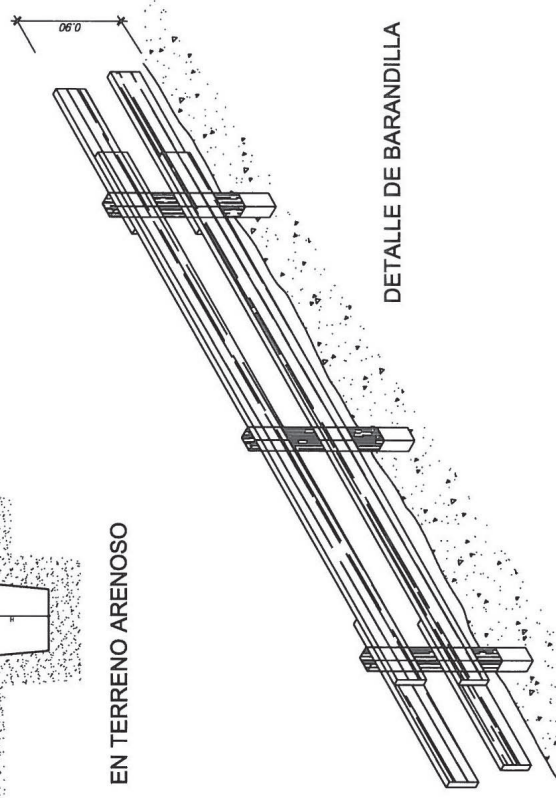

DETALLE DE BARANDILLA

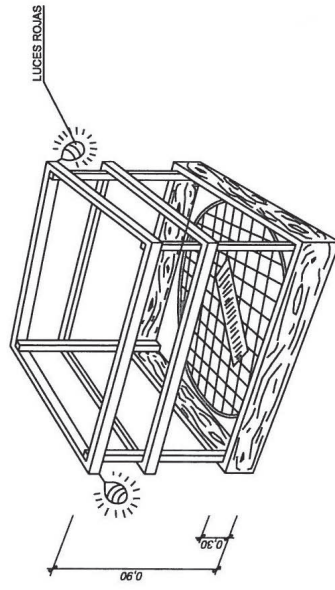

PROTECCIÓN EN HUECOS Y ABERTURAS

EXCAVACION

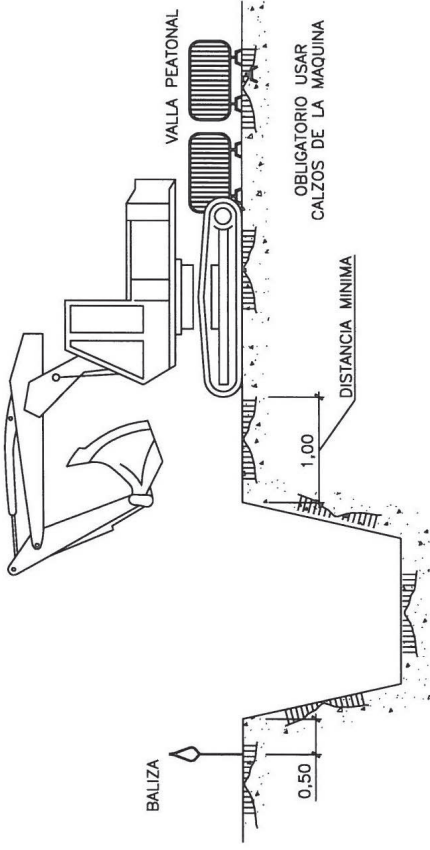

ACOPIOS

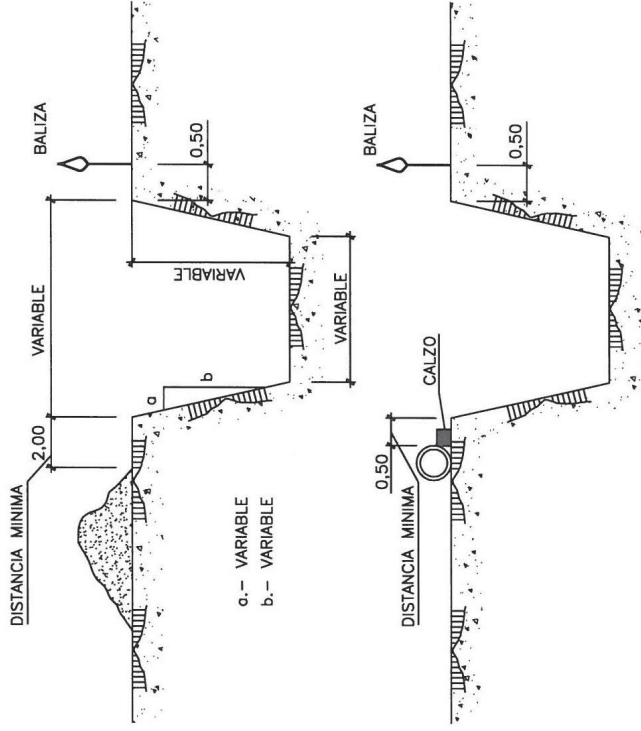

CARGA Y DESCARGA

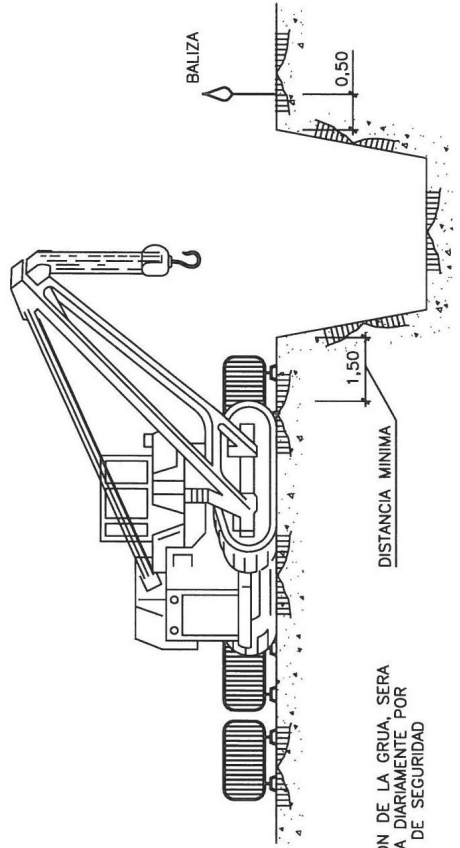
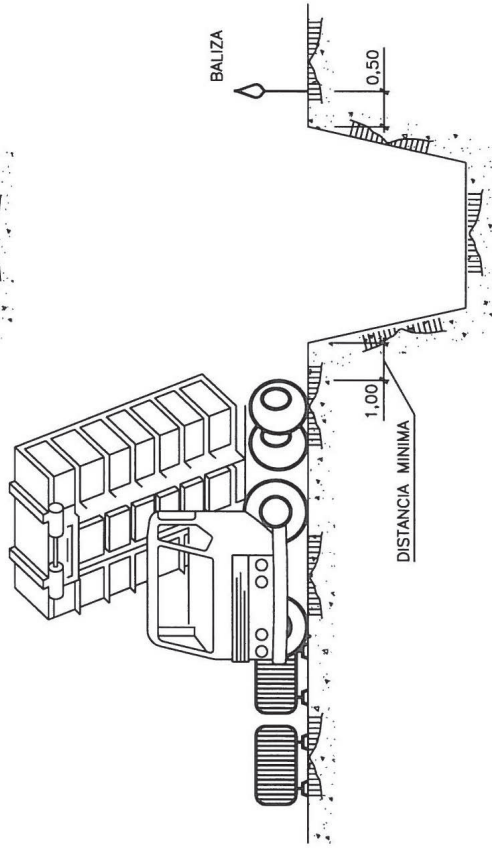
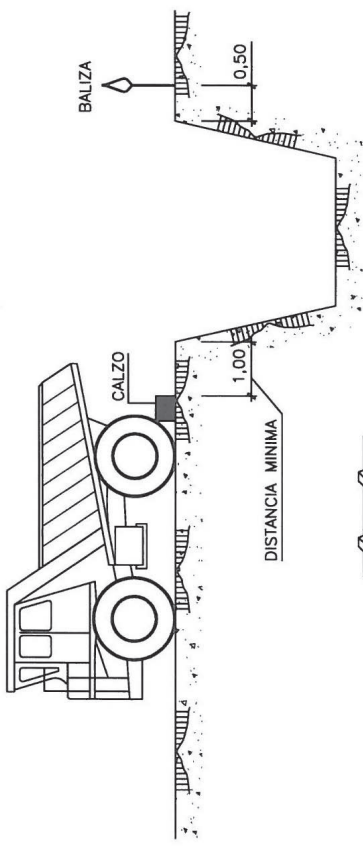

NOTA:
LA UBICACION DE LA GRUA, SERA
DETERMINADA DIARIAMENTE POR
EL TECNICO DE SEGURIDAD

HORMIGONADO POR VERTIDO DIRECTO EN ZANJAS O CIMENTACIONES

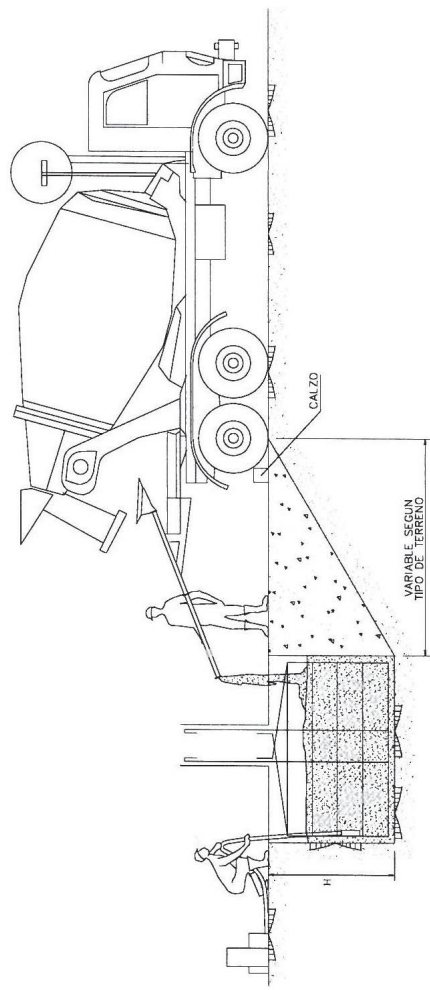
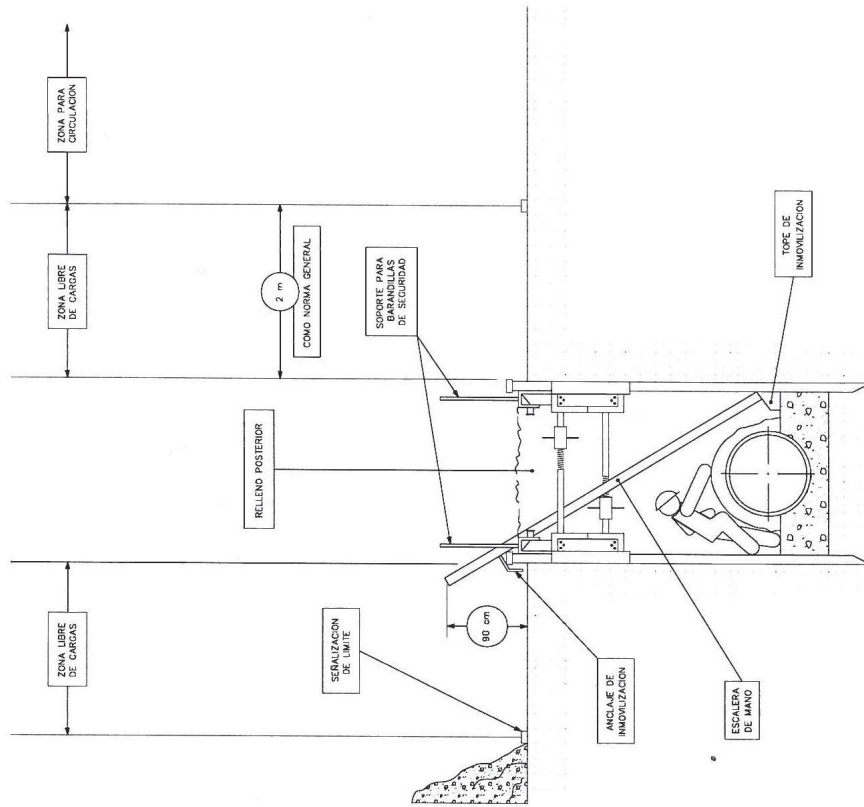

DETALLE DEL CALZO

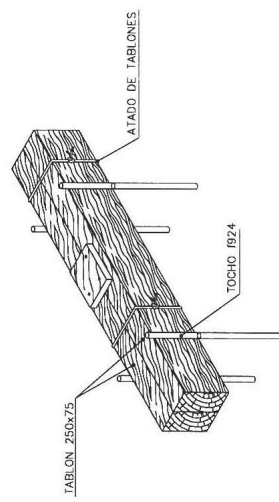

ENTIBACION EN ZANJAS

ANDAMIOS METÁLICOS TUBULARES

BRIDA CON ENCHUFE

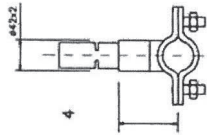

4

ABRAZADERA DE EMPALME

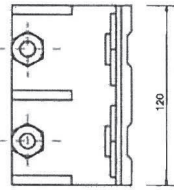

3

PIE DE BARANL

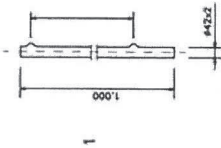

1

ABRAZADERA DOBLE FIJA DE HIERRO FORJADO

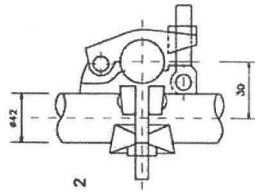

2

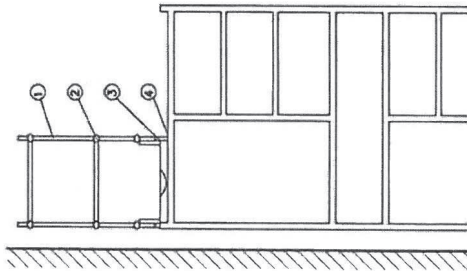

TIRANTE PARA BARANDILLA INTERIOR. TIPO G-100

ANDAMIO TIPO (m)	PESO/KG.	MEDIDAS
		A
DE 1.50	3.90	1.520
DE 2.00	4.80	2.035
DE 2.50	5.80	2.550
DE 3.00	6.80	3.063
DE 3.50	7.80	3.570
DE 4.00	8.80	4.075

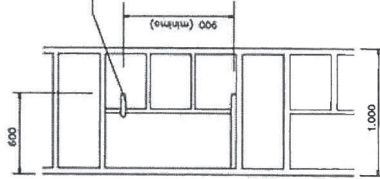

TIRANTE PARA BARANDILLA INTERIOR. TIPO G-150

ANDAMIO TIPO (m)	PESO/KG.	MEDIDAS
		A
DE 1.50	3.20	1.550
DE 2.00	4.20	2.035
DE 2.50	5.20	2.550
DE 3.00	6.20	3.063
DE 3.50	7.20	3.570
DE 4.00	8.20	4.075

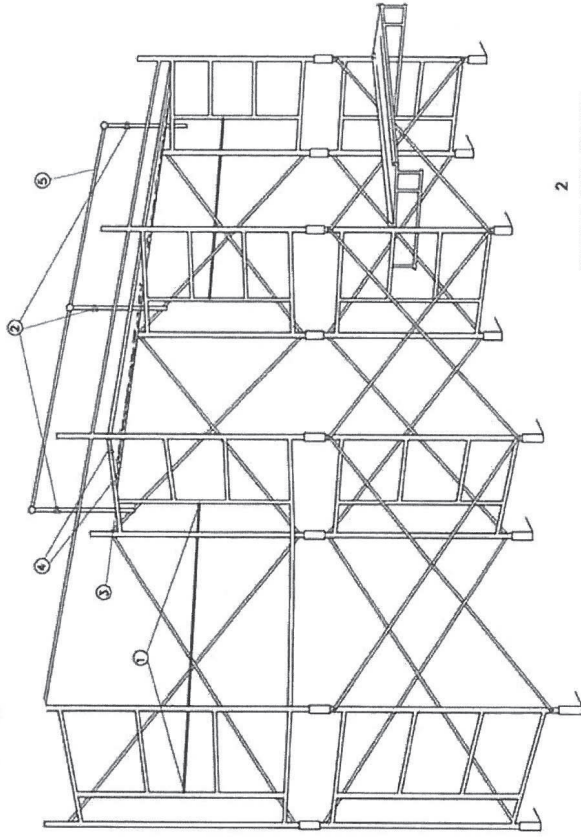
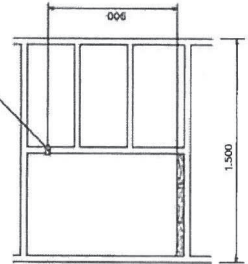

2 PILARILLO PARA FIJACION DE BARANDILLA

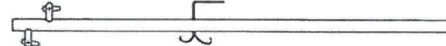

3

CASQUILLO CON BOCA

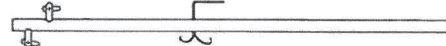

1 BOCA CON CURVA PARA FIJACION DE BARANDILLA

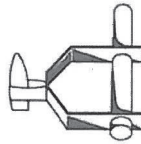

FIJACIONES DE RODAPIE

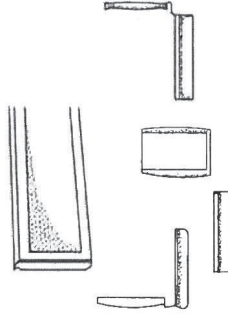

5 ALARGADERA DE BARANDILLA



4 PORTAPISE O PLATAFORMA METALICA DE 0.30 X 2 Y 3 mts.



ANDAMIOS TUBULARES

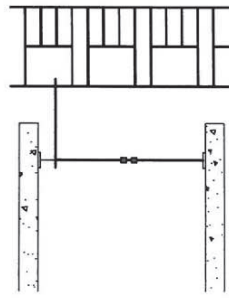

ARRIOSTRAR A FACHADA

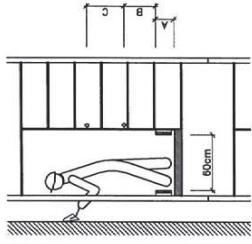

COLOCAR BARANDILLA
A:15cm. B:35cm. C:40cm.

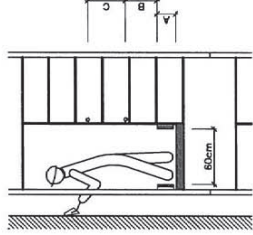

DISTANCIA AL PARAMENTO
MENOR O IGUAL A 30cm.

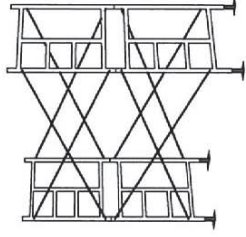

COLOCAR SOBRE TERRENO FIRME
UTILIZAR USILLOS NIVELACION

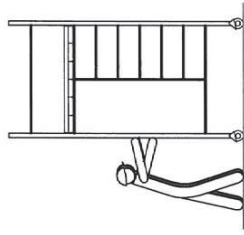

MOVER SIN CARGA

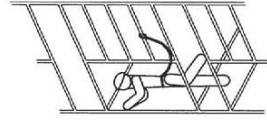

COLOCAR BARANDILLAS

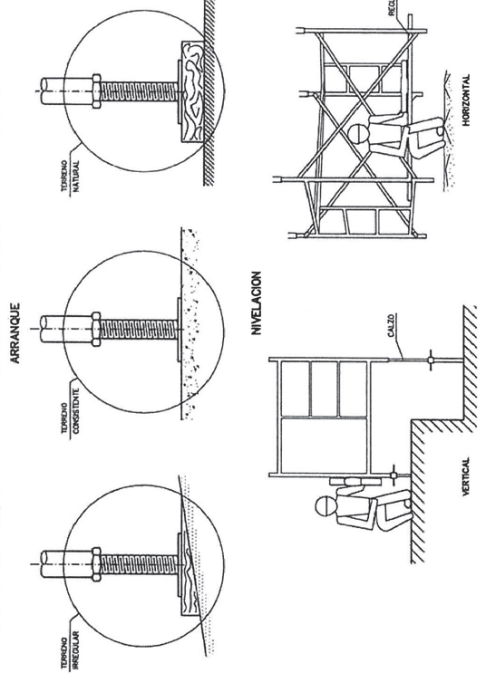

ESCALERAS DE MANO

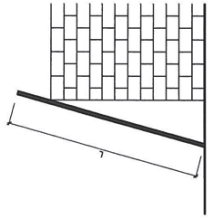

INCLINACION RECOMENDADA

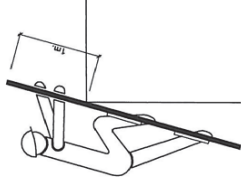

SOBREPASAR 1m. LA COTA MAXIMA

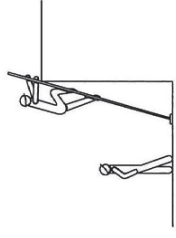

UN SOLO USUARIO A LA VEZ

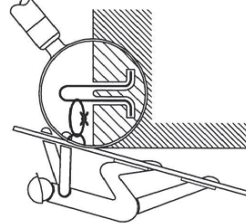

FORMA DE ARRIOSTRAMIENTO

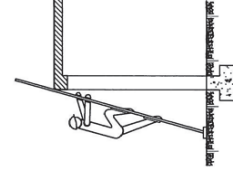

USAR ZAPATAS ANTIDESLIZANTES

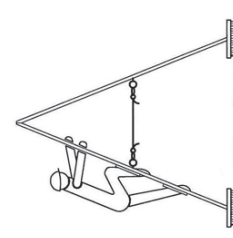

LAS ESCALERAS DE TIJERAS DEBEN DISPONER DE CUERDA O CADENA Y DE ZAPATAS ANTIDESLIZANTES

USAR CINTURON EN MONTAJE

REDES PERIMETRALES CON SOPORTE METALICO
TIPO HORCA

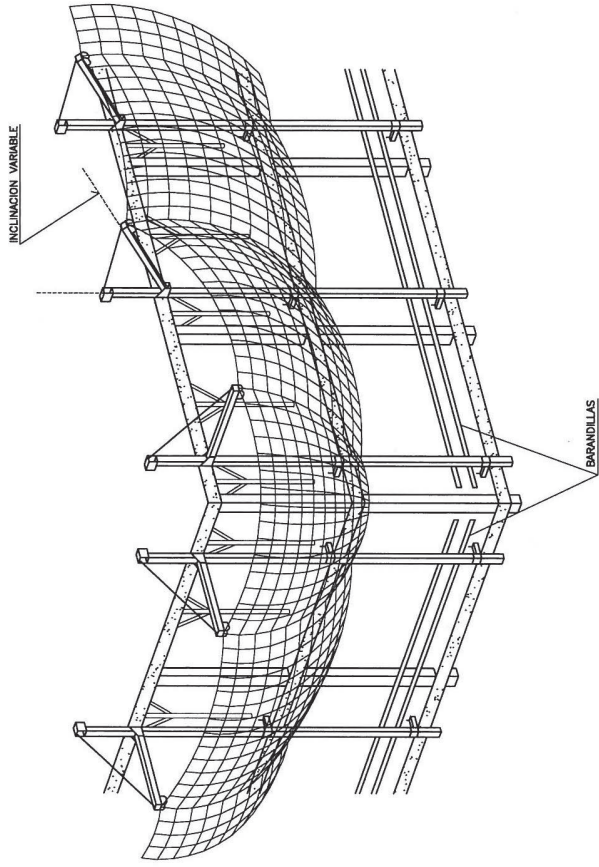

BARANDILLA CON SOPORTE TIPO "SARGENTO"

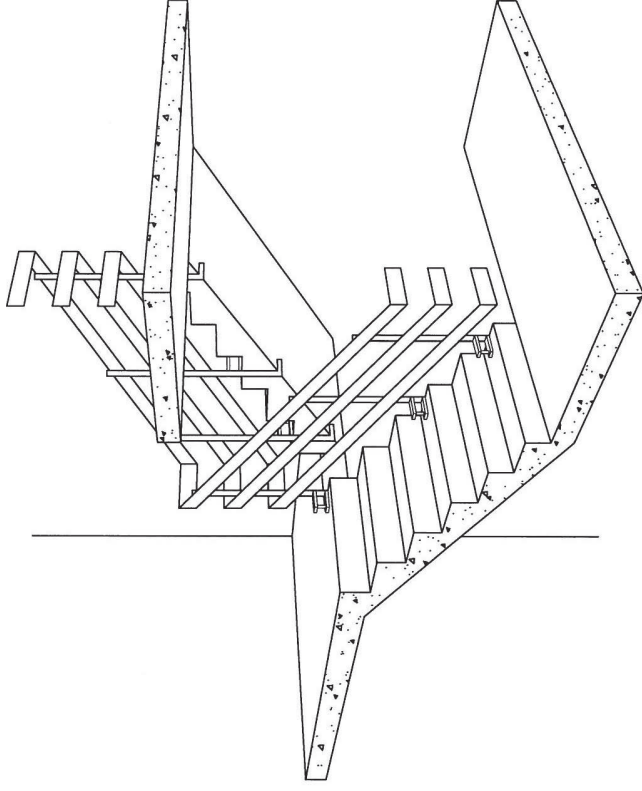

DETALLE-4

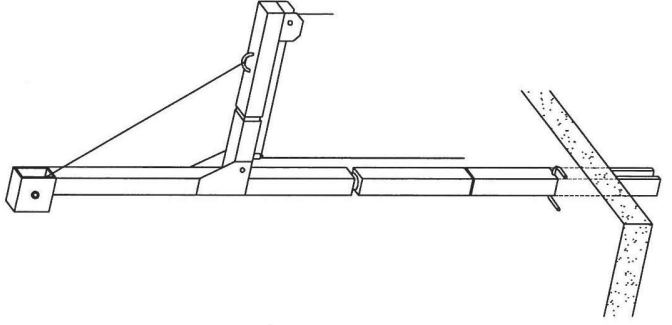

DETALLE-1

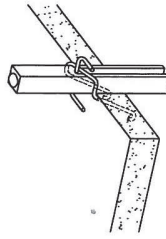

DETALLE-2

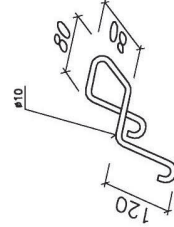

DETALLE-3

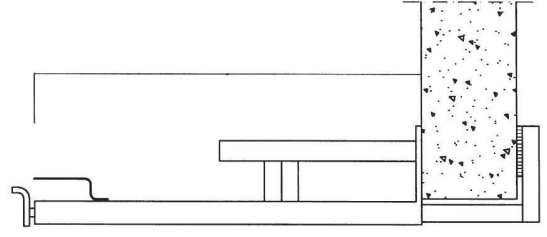
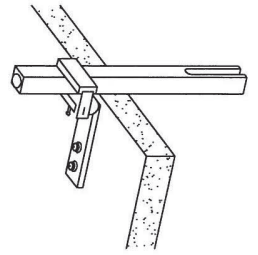

TIPO-3

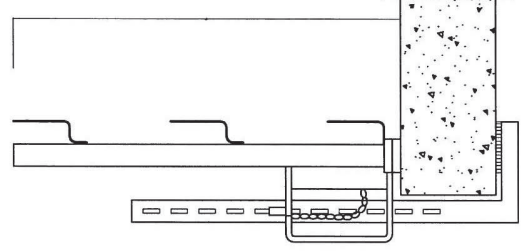

TIPO-2

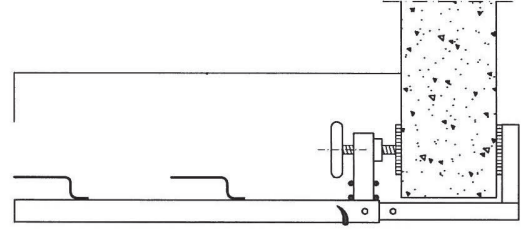

TIPO-1

BARANDILLA CON SOPORTES DE MORDAZA

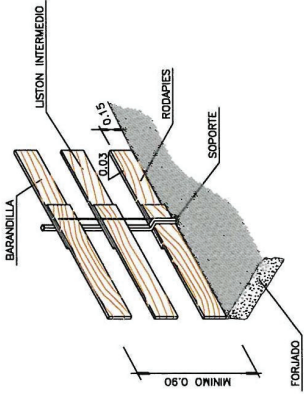
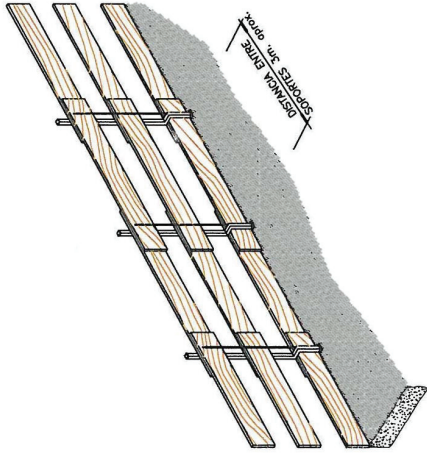

SOPORTE CON CUÑA

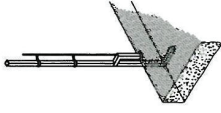

SOPORTE CON HUSILLO

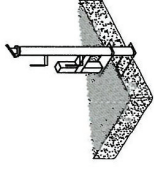

LA MADERA UTILIZADA HABRA SIDO PREVIAMENTE SELECCIONADA Y NO SE UTILIZARA PARA OTRO FIN

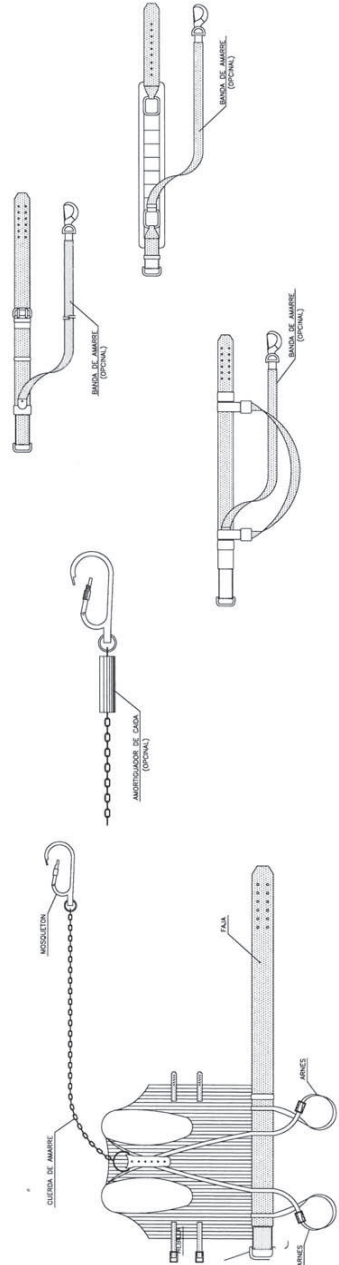
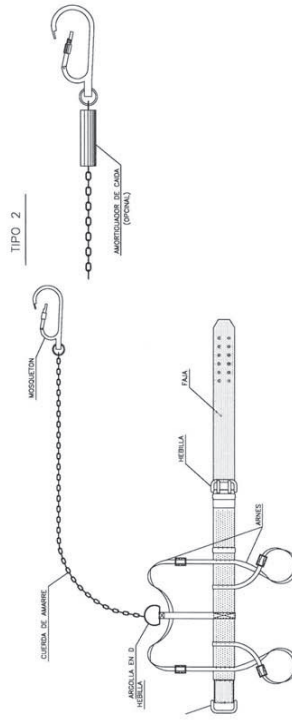
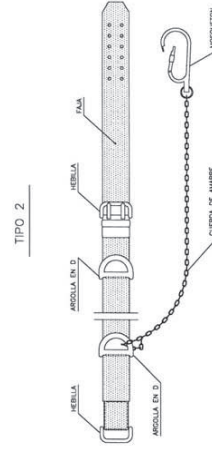
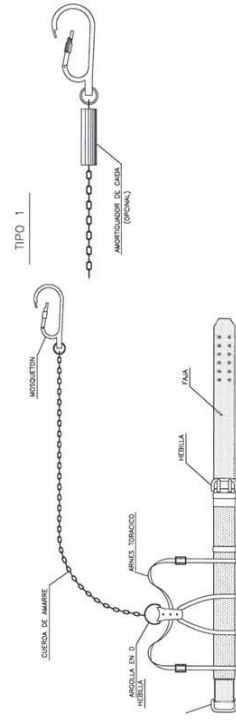
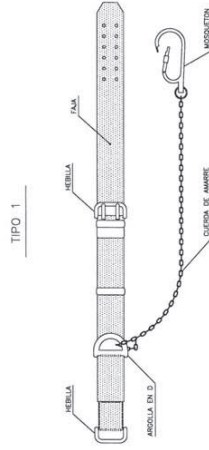
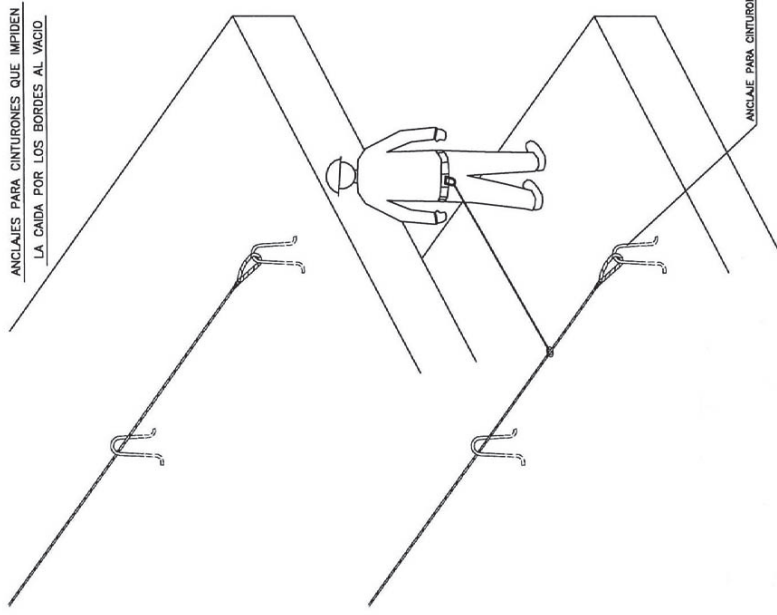

USO CORRECTO DE CABLES Y ESLINGAS

DIAMETRO DEL CABLE	Carga de trabajo útil en Kg. para cables con resistencia específica de 160kg/mm ²																																																																																																																																																			
	1.330	1.000	2.680	2.570	2.300	1.880	5.320	5.140	4.600	3.760	1.680	3.360	3.240	2.900	2.370	6.720	6.480	5.800	4.740	2.300	1.720	4.600	4.440	3.980	3.250	9.200	8.880	7.960	6.500	3.000	2.250	6.000	5.790	5.200	4.240	12.000	11.580	10.400	8.400	3.580	2.680	7.160	6.910	6.200	5.060	14.320	13.820	12.400	10.120	3.970	2.980	7.940	7.670	6.870	5.610	15.880	15.340	13.740	11.720	4.800	3.600	9.600	9.270	8.310	6.790	19.200	18.540	16.620	13.580	5.700	4.280	11.400	11.010	9.870	8.060	22.800	22.020	19.740	16.120	6.720	5.040	13.440	12.980	11.640	9.500	26.880	25.960	23.280	19.000	7.780	5.910	15.560	15.030	13.470	11.000	31.120	30.060	26.940	22.000	8.350	6.260	16.700	16.130	14.460	11.800	33.400	32.260	28.920	23.600	9.530	7.150	19.060	18.410	16.500	13.470	36.120	36.820	33.000	26.940	10.820	8.120	21.640	20.900	18.740	15.300	43.280	41.800	37.480	30.600	12.170	9.130	24.340	23.510	21.070	17.210	48.680	47.020	42.140	34.420	13.590	10.200	27.180	26.250	23.530	19.210	54.360	52.500	47.080

MUY IMPORTANTE:

LA INSPECCION DE CABLES Y ESLINGAS DEBE REALIZARSE DE FORMA PERMANENTE CON LOS CRITERIOS INDICADOS A CONTINUACION

N° de alambres de cables según Norma DIN 655	N° de alambres rotos del cable cuando éste debe desecharse	
	Arrollamiento cruzado	
6x19=114	8	LONGITUD 30d
6x37=222	30	16
		60

-Un cable también debe retirarse cuando tenga un cordón roto.
-Así mismo debe retirarse cuando presente ensanchamientos, aplastamientos, dobleces y otros deterioros similares.

NOTA: En los pulpos de 4 ramales el ángulo debe de tomarse para el cálculo entre ramales opuestos.

-El coeficiente de seguridad adoptado es de 6.
-D=Diámetro del cable.

CARGA LARGA (DOS ESLINGAS)

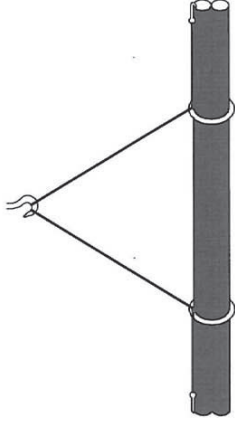

PLANCHA LARGA

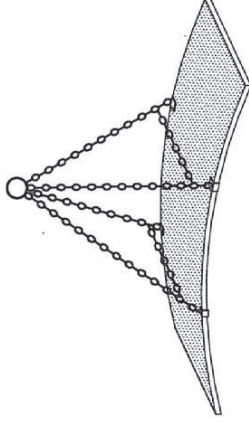

CARGA CON DOS ESLINGAS SIN FIN

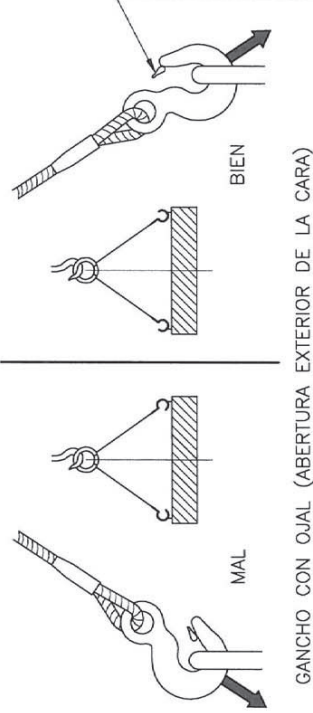
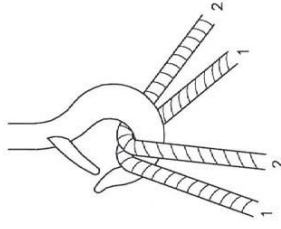
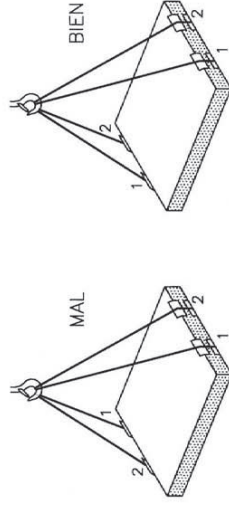

GANCHO CON OJAL (ABERTURA EXTERIOR DE LA CARA)

AMARRE DE BIDONES

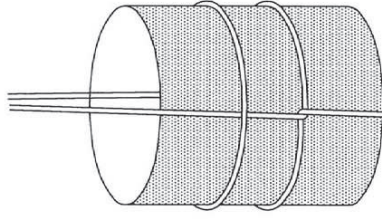

BALIZAMIENTO EN CORTES DE CARRETERA CON DESVÍO

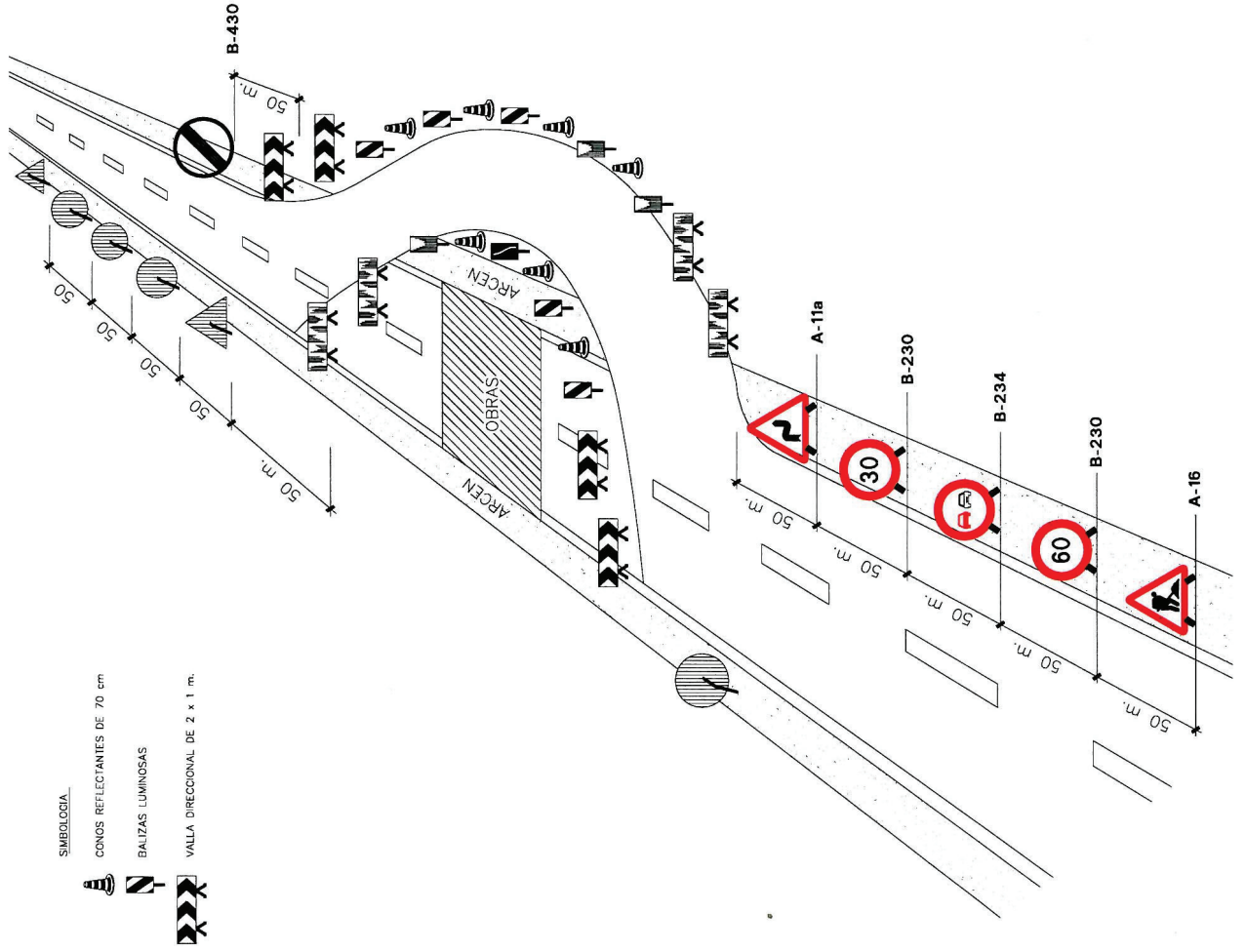

- SMBOLOGIA
- CONOS REFLECTANTES DE 70 cm
- BALIZAS LUMINOSAS
- VALLA DIRECCIONAL DE 2 x 1 m.

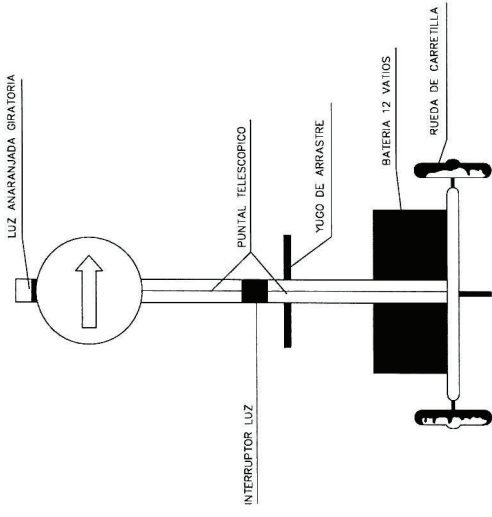

VISTA FRONTAL

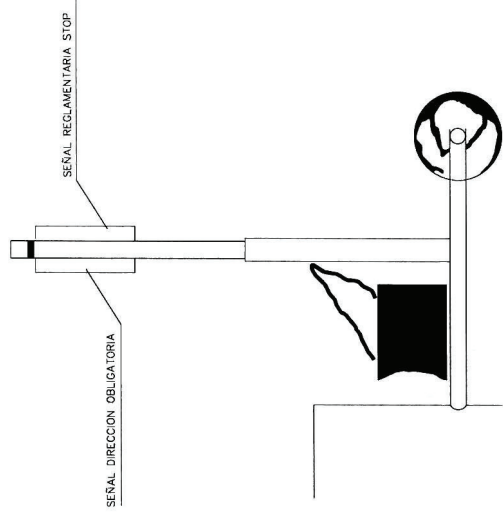

VISTA LATERAL

SEÑAL PORTATIL PARA REGULACION DEL TRAFICO EN CARRETERA